

Hepplewhite[®]
Fitted Bedrooms & Home Offices

Product Manual

Sliding Wardrobes

*For more information about our ranges and technical
information please refer to your price list and the
trade area within our website at
www.hepplewhitefittedfurniture.co.uk
Please call 01455 236019 for more information.*

*Date of Issue: November 2013
Uncontrolled Document*

Please see the list below to refer to range names for Hepplewhite:

<p>Hepplewhite Range Name</p> 	<p>Hammonds Range Name</p> 
Albany	Willoughby
Boston	Cantare
Bosworth	Willesley
Carnaby	Fusion
Charlotte	Palladian
Fairfield	Helmsley
Graphica	Verve
Harewood	Melody
Kingsbury	-
Latitude	Horizon
Linear	-
Lustro	Elkin
Mayfair	Somerset
Milan	Libretto
Moda	Vigo
Panorama	Moderna
Prima	Rialto
Solo	Radley

STANDARD RUNS

NOTE
Add up to 55mm to unit height
for floor scribe

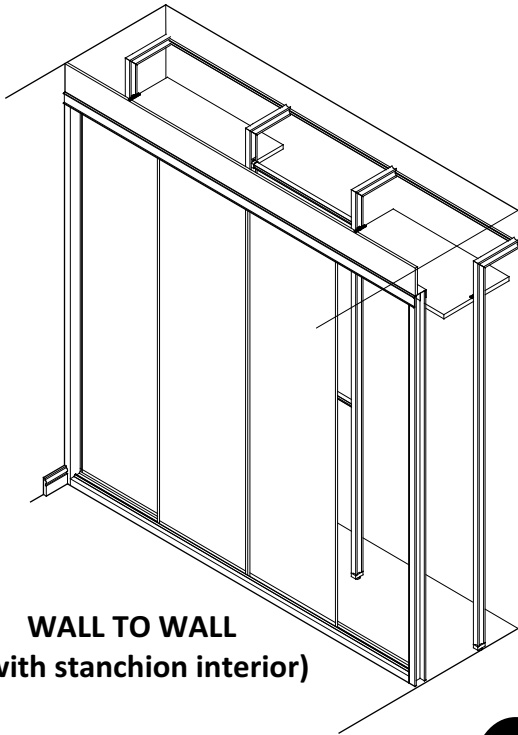

WALL TO WALL
(with stanchion interior)

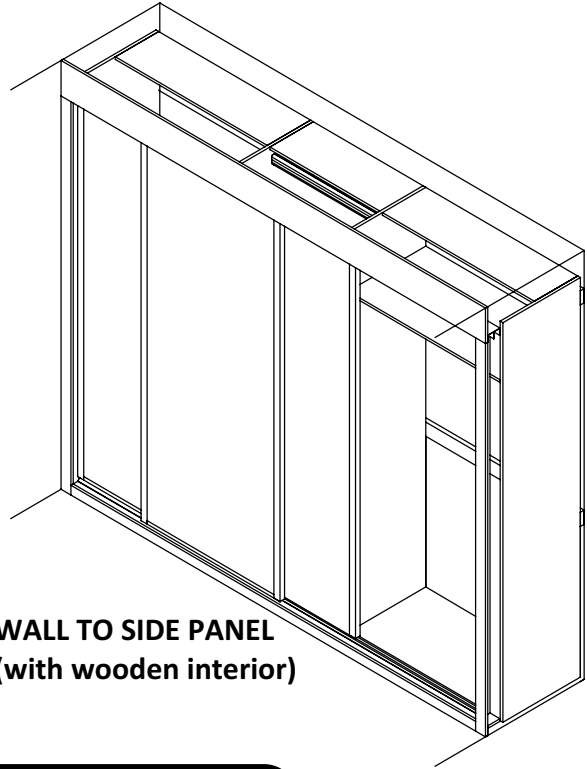

WALL TO SIDE PANEL
(with wooden interior)

NOTE
Runs should not be planned with a
side panel at both ends

WALK-IN CLOSET

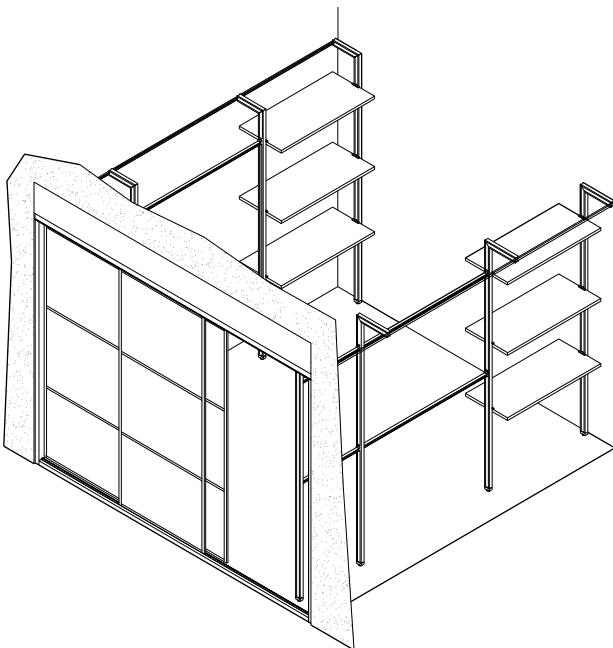

showing stanchion interior

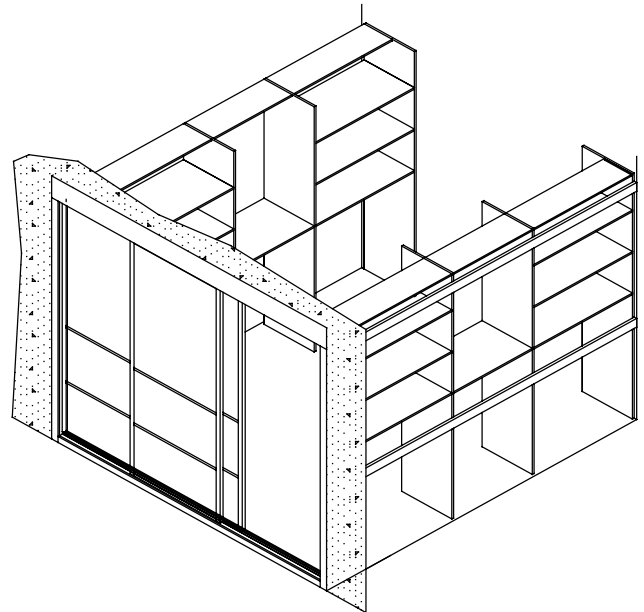

showing wooden interior

RUNS OF DOORS SHOULD
BE POSITIONED AS SHOWN

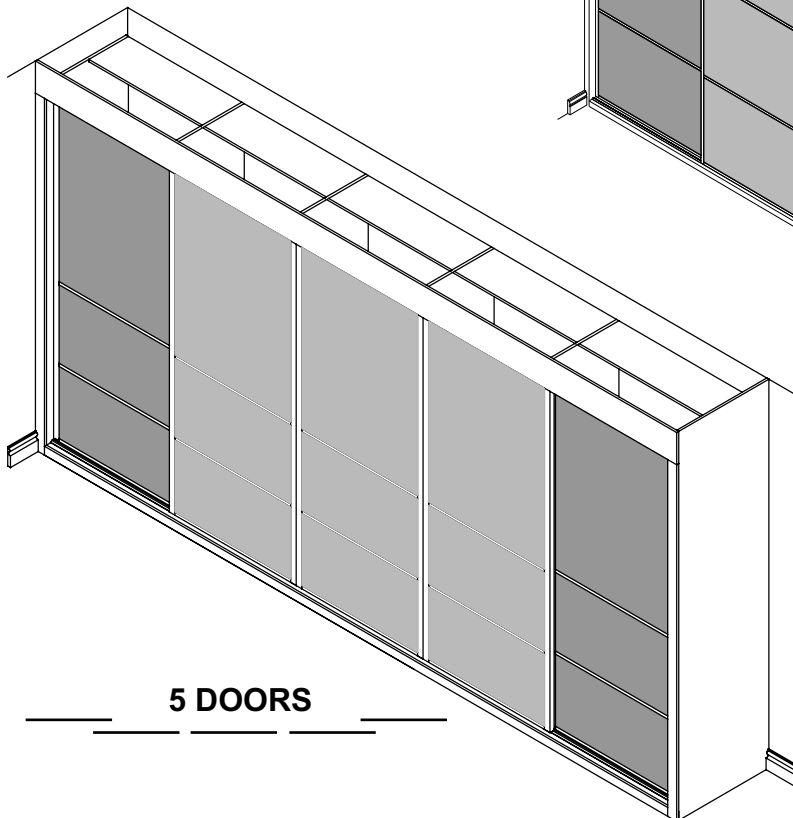
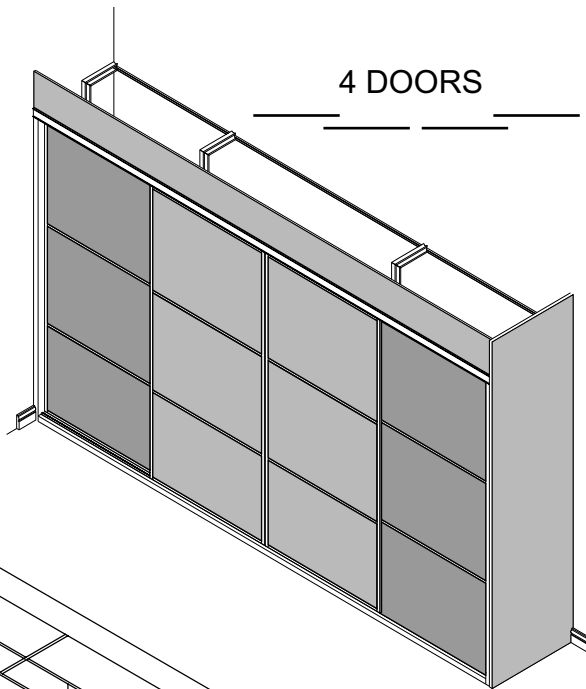
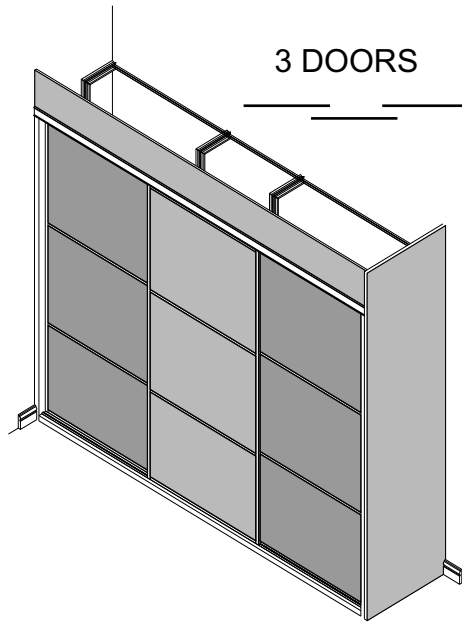
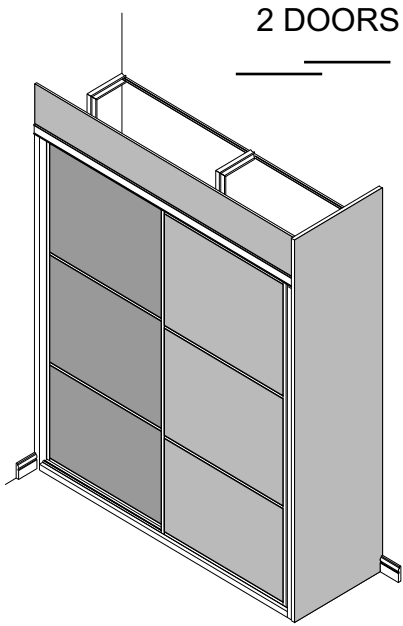

DOOR WIDTHS

Five widths and 4 heights available

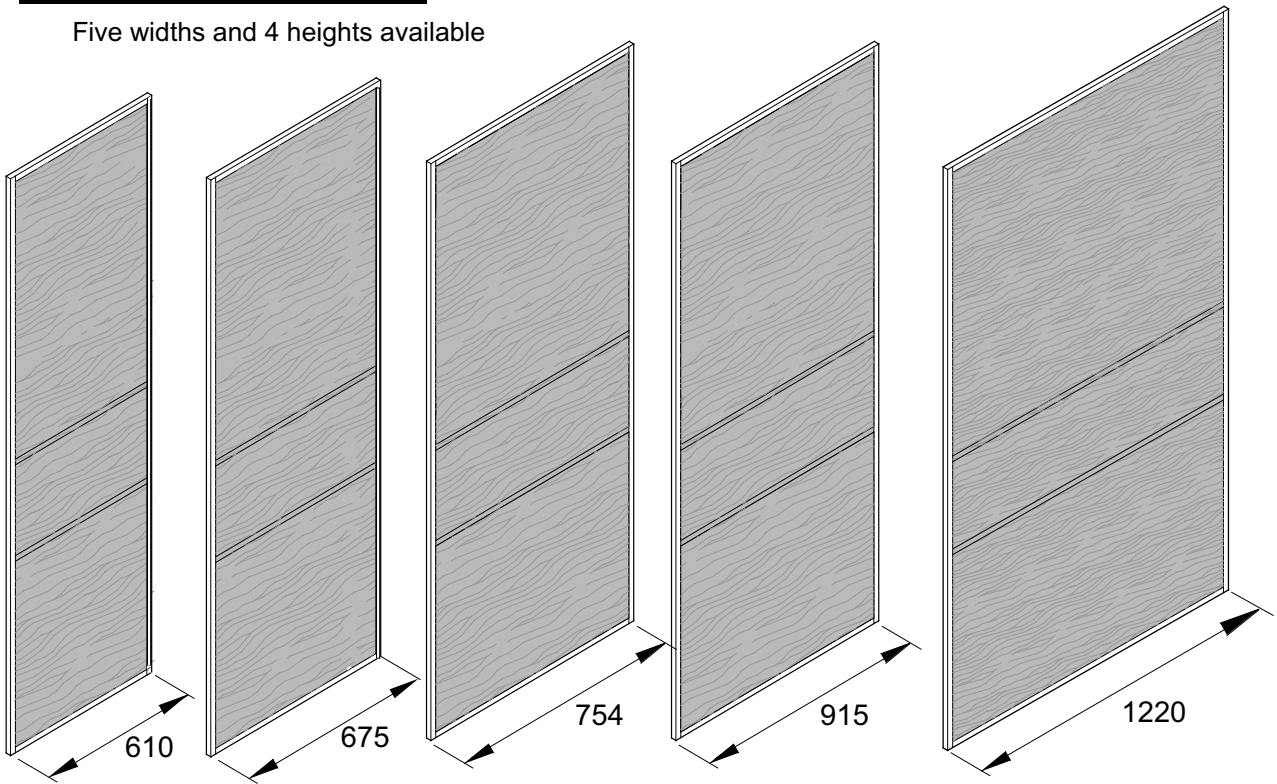

DOOR HEIGHTS

For 2300 unit height

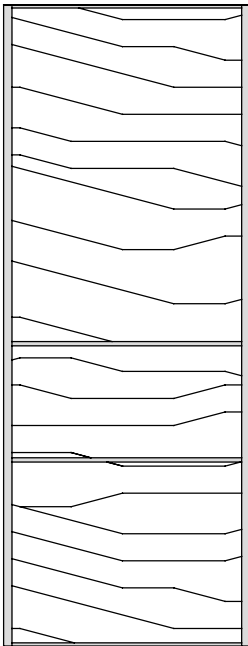

For 2205 unit height

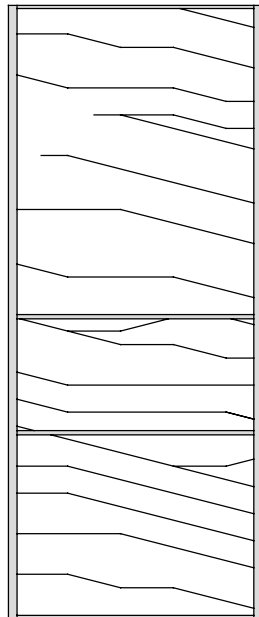

For 2090 unit height

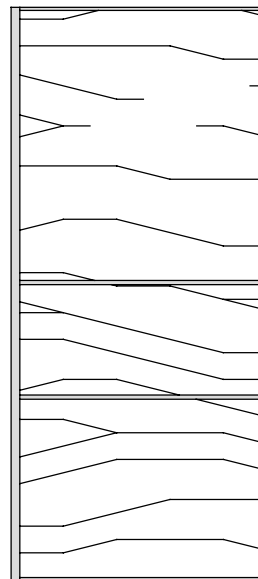

For 1977 unit height

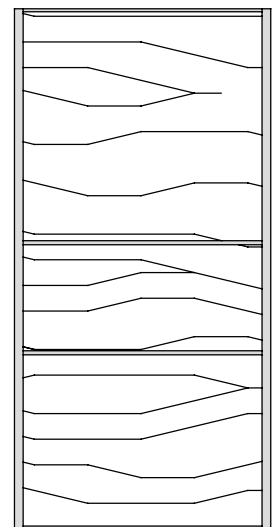

NOTE

5 Panel doors are only available at 2090 height

RESTRICTIONS

OVERLAPS

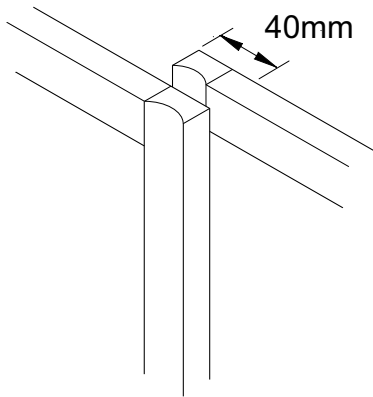

Angular restriction only applies to fully angled door (no flat area at top of door)

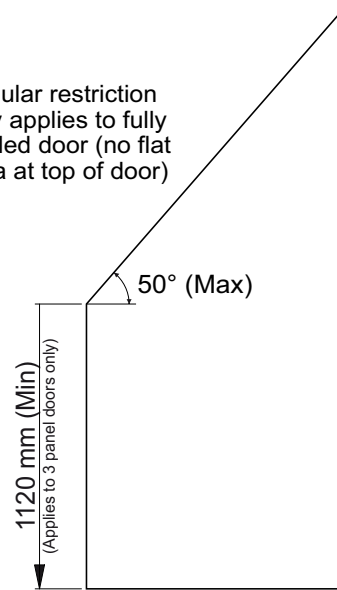

NOTE

Where angled doors are to be included in a run of doors, AT LEAST 2 of all of the doors MUST NOT BE angled. Furthermore, the non angled doors must be fitted next to each other to ensure the correct operation of all doors!

NON-PROFILED SHELVES

(Must be used behind ANGLED doors)
(Can be reduced in width & depth)

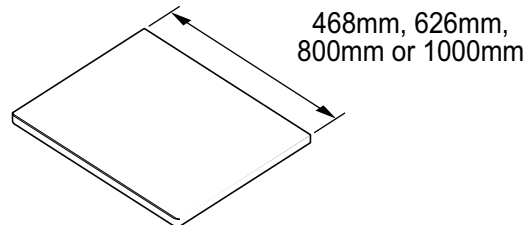

DOOR CONFIGURATIONS

3 Doors (Minimum 2 Doors must not be angled)

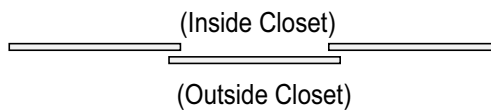

4 Doors (Minimum 2 Doors must not be angled)

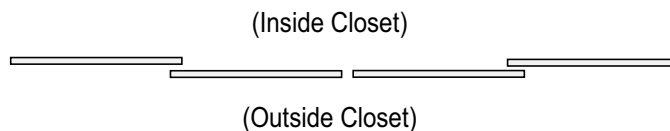

CONSIDERATIONS

It is recommended that only two Angled Doors are fitted next to each other wherever possible.

A shelf (including mounting track) must be fitted behind Angled Doors to ensure correct operation.

OVERLAPS

max 70mm for 610, 675 and 754 doors
 max 100mm for 915 doors
 max 130mm for 1220 doors

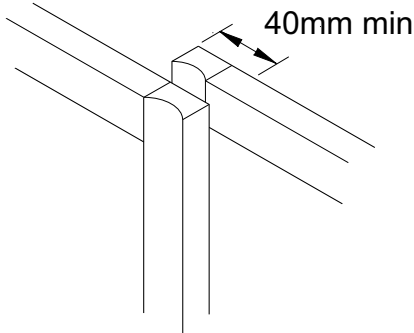

HANDLES

The smooth hollow in the upright functions as an integrated handle

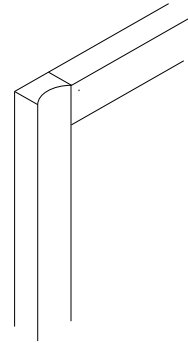

SCRIBES & INFILLS

WIDE SIDE SCRIBE

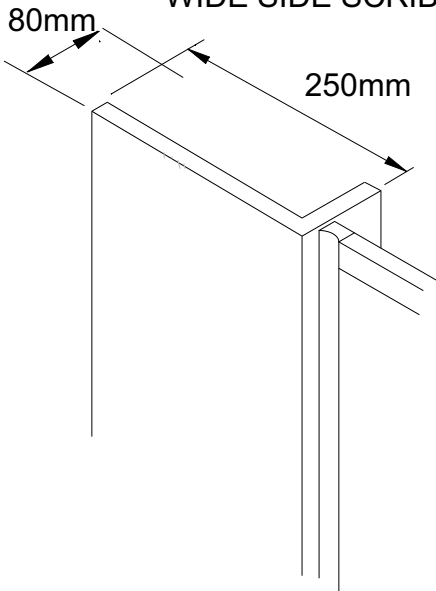

TOP INFILL

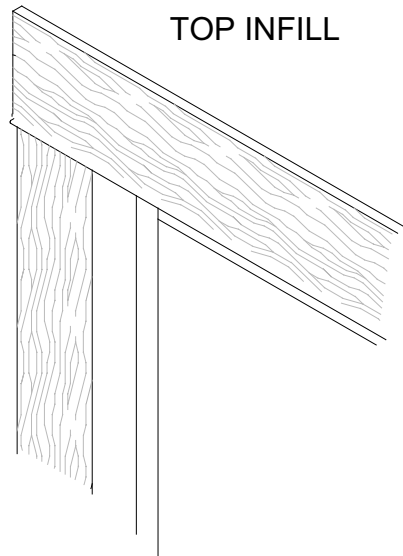

NARROW SIDE SCRIBE

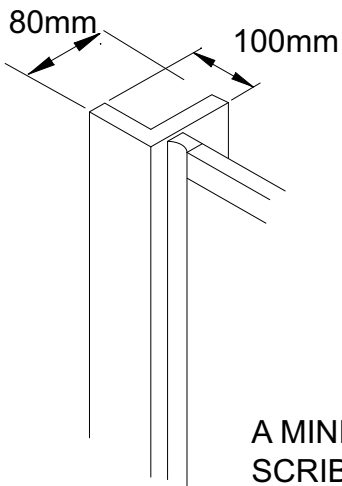

A MINIMUM 65mm SIDE
 SCRIBE MUST BE PLANNED

FLOOR SCRIBE

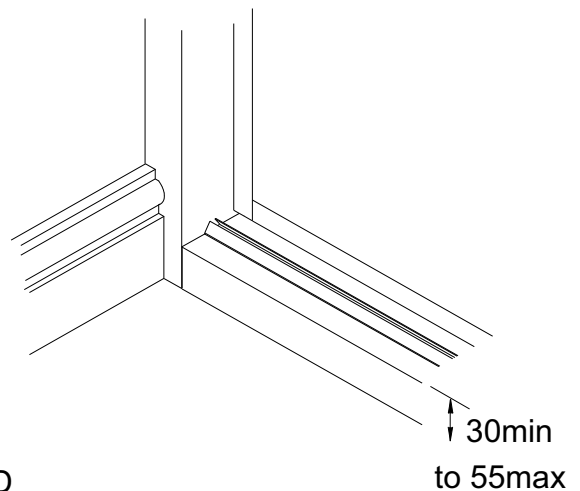

HANGING RAIL

(shown between Stanchions)

Can be cut down in length

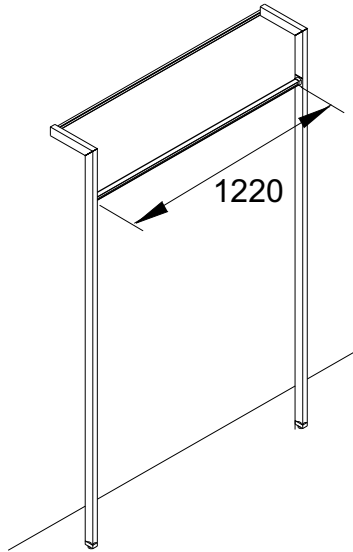

SHOE RAIL

Can be cut down in length

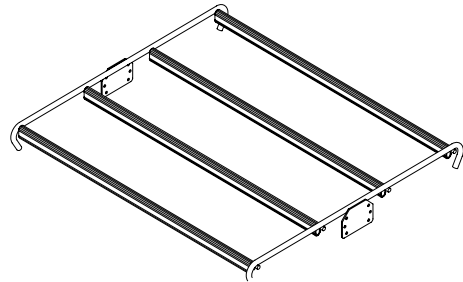

SHELVES

Available in four widths

Can be reduced in depth but NOT in width

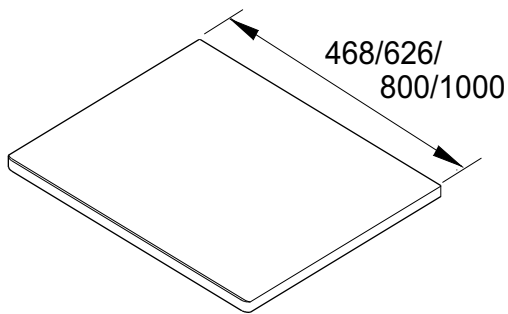

CHESTS

Available in two widths

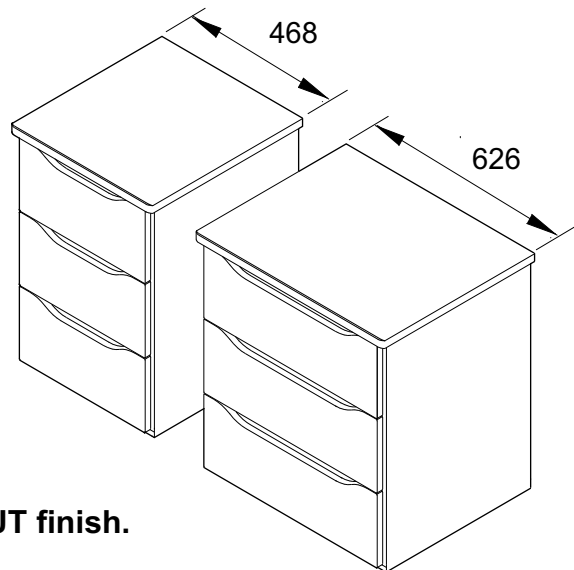

Available in PEARWOOD & URBAN WALNUT finish.

NOTE

Chests should not be planned in configurations containing 610mm & 675mm doors

A

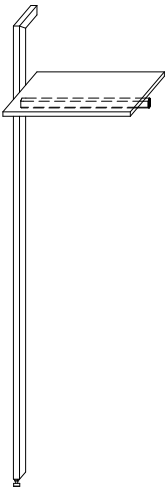

B

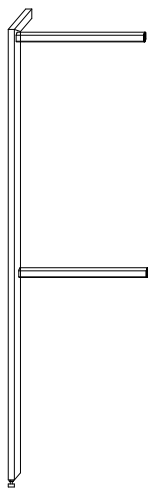

B2

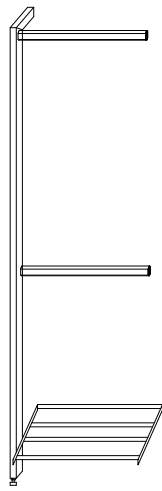

B3



B4

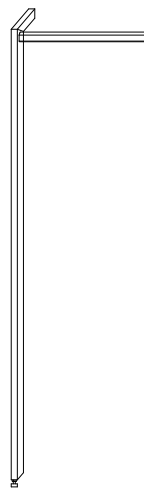

C

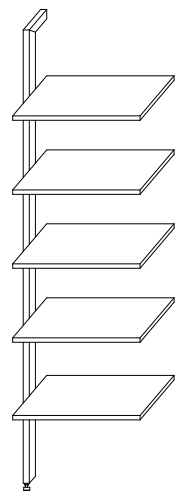

D

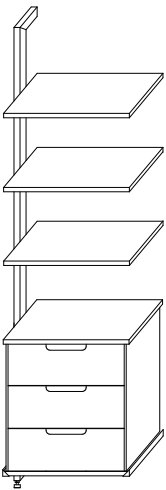

E

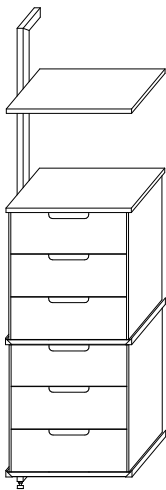

F

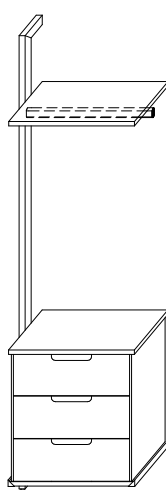

G

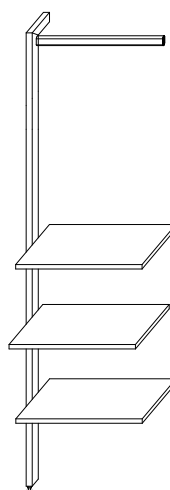

H

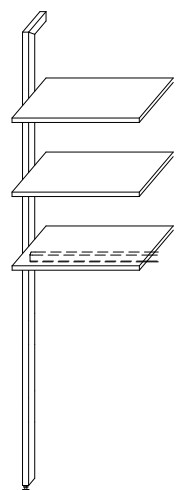

J

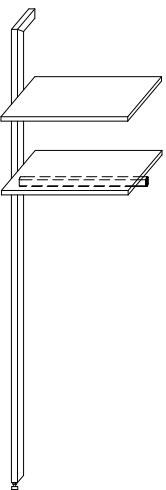

K

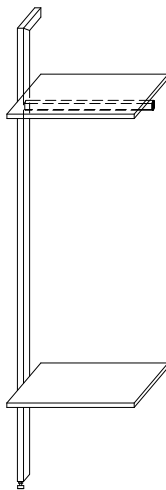

L

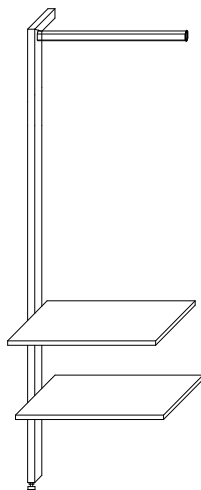

L2

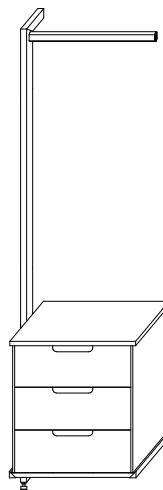

M

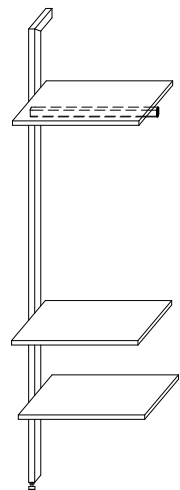

YOU MUST ALWAYS START AND FINISH AN INTERNAL RUN WITH THE INTERNAL SIDE

Available in PEARWOOD & URBAN WALNUT finish.

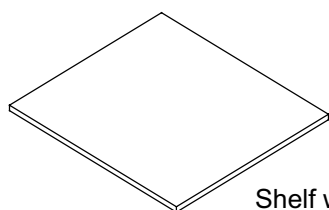
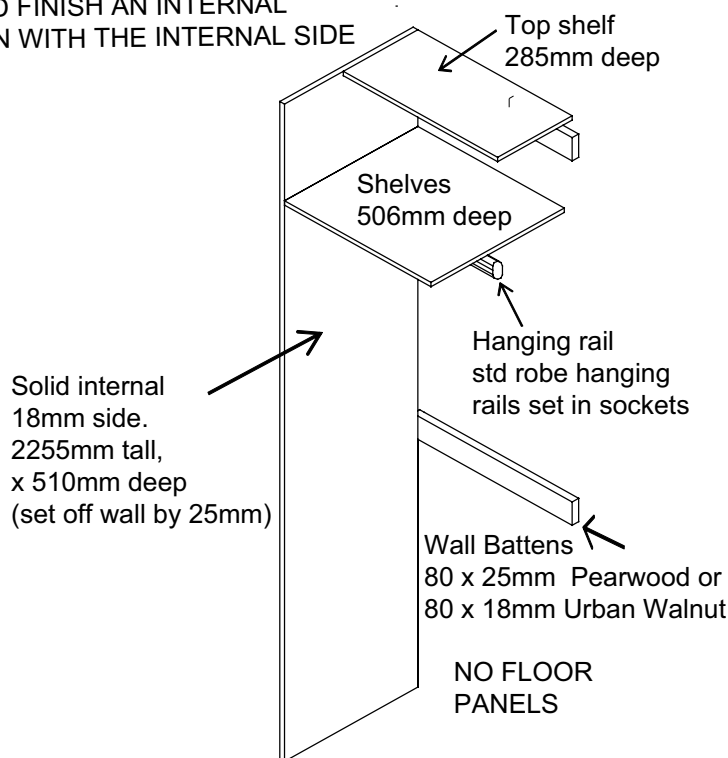

Shelf widths available 412, 560, 790 & 997mm set on captured shelf pegs. (Can be cut to width or depth)

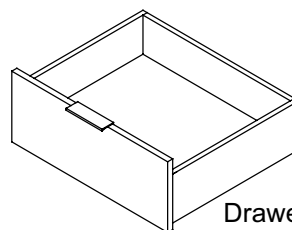

Drawer widths available for 412 & 560mm width only (max of 5 high) 238mm high front plus handle.

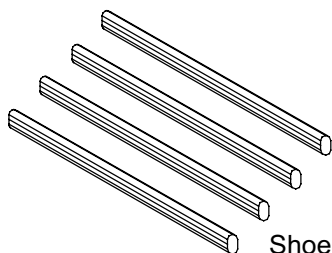



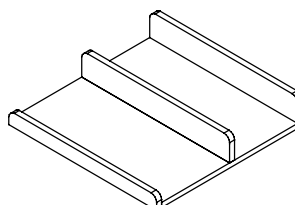

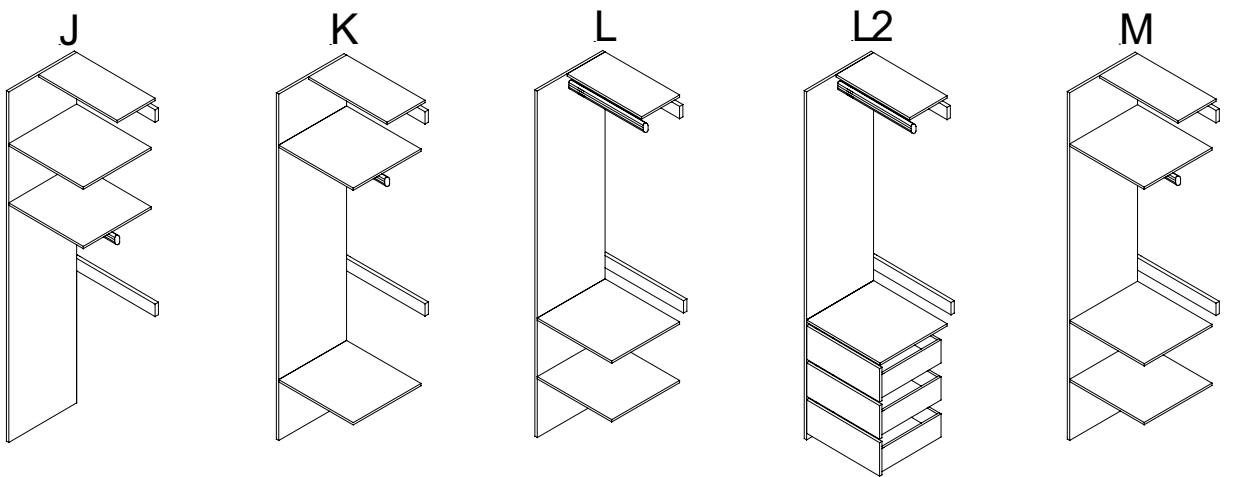
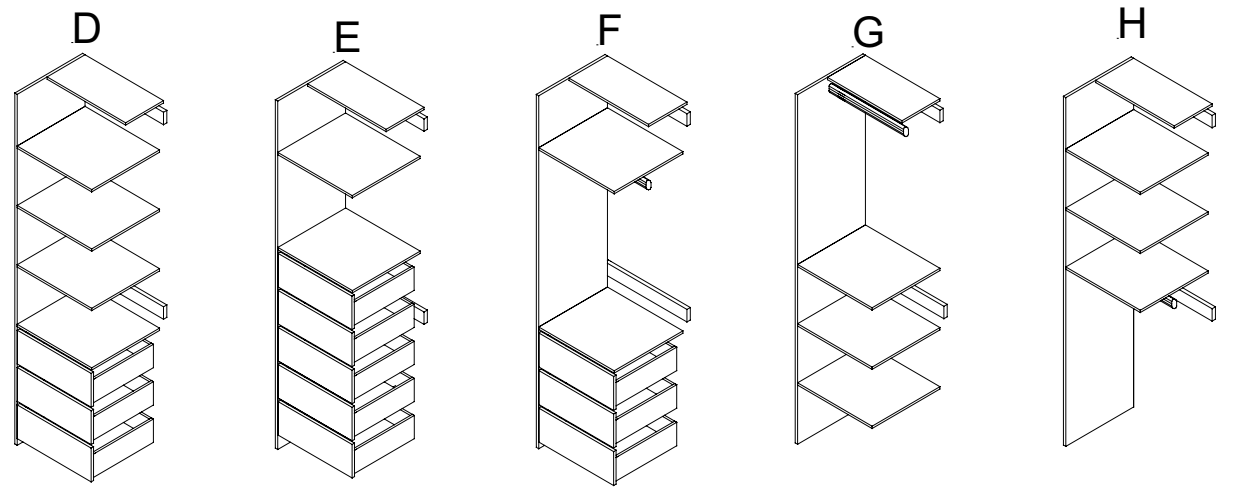
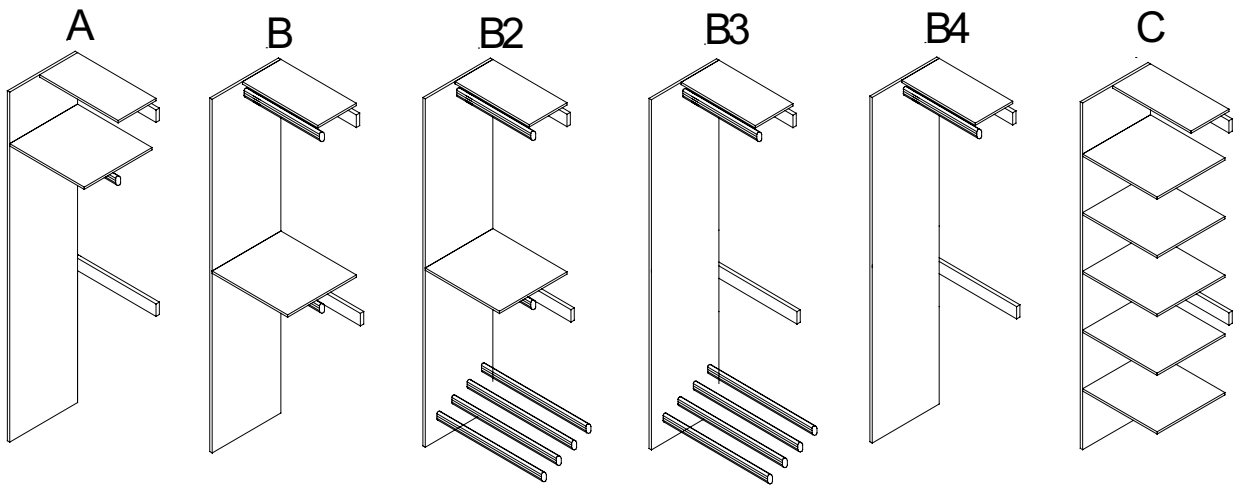

Shoe Rail widths available 412, 560, 790 & 997mm supplied as 4 hanging rails set in sockets.

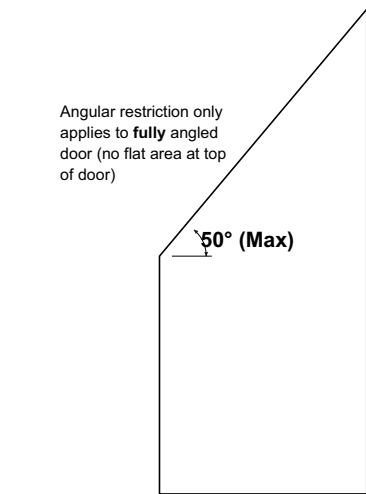
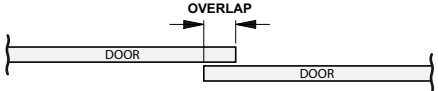
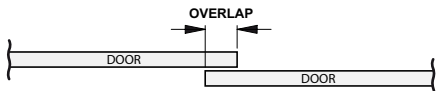
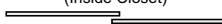
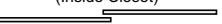
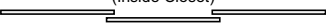

Pull out Shoe Trays available for 412 & 560mm width only (max of 5 high)

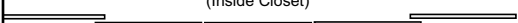
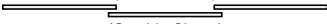

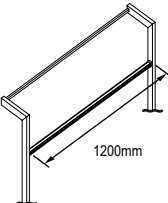
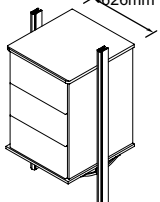
SLIDING WARDROBES

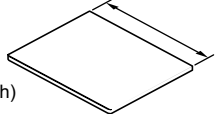
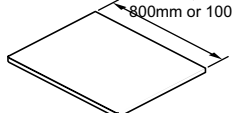
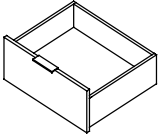
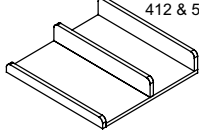
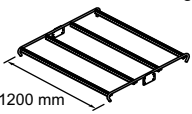
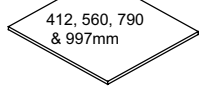
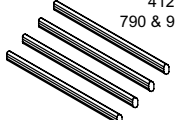
STANDARD DETAILS				ANGLED DOOR DETAILS		DESIGN CONSIDERATIONS	
UNIT HEIGHTS				ANGLED DOOR RESTRICTIONS			
DOOR WIDTHS							
CAN BE ANGLED							
Doors						<p>Closet runs should not be designed with a side panel at both ends.</p> <p>Internal Chests should not be planned in configurations containing 610mm Doors.</p> <p>All Doors are Soft Close Angled Doors CANNOT have Soft Close.</p> <p>It is recommended that only two Angled Doors are fitted next to each other wherever possible.</p> <p>A shelf (including mounting track) must be fitted behind Angled Doors to ensure correct operation.</p>	
Standard Panel	1977, 2090, 2205, 2300	610, 675, 754, 915, 1220	YES				
Mirrored	1977, 2090, 2205	610, 675, 754, 915	NO				
5 Panel doors	2090	610, 675, 754, 915, 1220	NO				
DOOR DETAILS (NOT ANGLED)				DOOR DETAILS (ANGLED DOORS)			
Door Overlaps (Plan view)				Door Overlaps (Plan view)			
							
Door width	Min Overlap	Max Overlap		Door width	Overlap		
610	40mm	70mm		610	40mm		
675	40mm	70mm		675	40mm		
754	40mm	70mm		754	40mm		
915	40mm	100mm		915	40mm		
1220	40mm	130mm		1220	40mm		
Door Configurations (Plan views)				Door Configurations (Plan views)			
<p>2 Doors (LH) (Inside Closet)</p>  <p>(Outside Closet)</p> <p>2 Doors (RH) (Inside Closet)</p>  <p>(Outside Closet)</p> <p>3 Doors (Inside Closet)</p>  <p>(Outside Closet)</p> <p>4 Doors (Inside Closet)</p>  <p>(Outside Closet)</p> <p>5 Doors (Inside Closet)</p>  <p>(Outside Closet)</p>				<p>Note: Where angled doors are to be included in a run of doors, AT LEAST 2 of all of the doors MUST NOT BE angled. Furthermore, the non angled doors must be fitted next to each other to ensure the correct operation of all doors!</p> <p>3 Doors (Minimum 2 Doors must not be angled) (Inside Closet)</p>  <p>(Outside Closet)</p> <p>4 Doors (Minimum 2 Doors must not be angled) (Inside Closet)</p>  <p>(Outside Closet)</p>			
Doors CANNOT be altered in height or width				Doors CANNOT be altered in height or width (Fully angled doors will naturally alter in height)			
CONTEMPORARY INTERIORS				WOODEN INTERIORS			
<p>HANGING RAIL (Can be cut down in length) (Shown between Stanchions)</p>  <p>1200mm</p>		<p>INTERNAL CHESTS 468mm, 626mm</p> 		<p>HANGING RAILS 4 widths 412, 560, 790 & 997mm</p> 		<p>Available in PEARWOOD & URBAN WALNUT finishes.</p>	
<p>SQUARE EDGED SHELVES Available in four widths</p> 		<p>ANGLED SHELVES (For use behind ANGLED doors) (Can be reduced in width & depth) 468mm, 626mm, 800mm or 1000mm</p> 		<p>INTERNAL DRAWERS 2 widths 412 & 560mm</p>  <p>Solid internal 18mm sides</p>		<p>PULL OUT SHOE TRAYS 2 widths 412 & 560mm</p> 	
<p>SHOE RAIL (Can be cut down in length)</p>  <p>1200 mm</p>		<p>SHELVES 4 widths 412, 560, 790 & 997mm</p> 		<p>SHOE RAILS 4 widths 412, 560, 790 & 997mm</p> 			

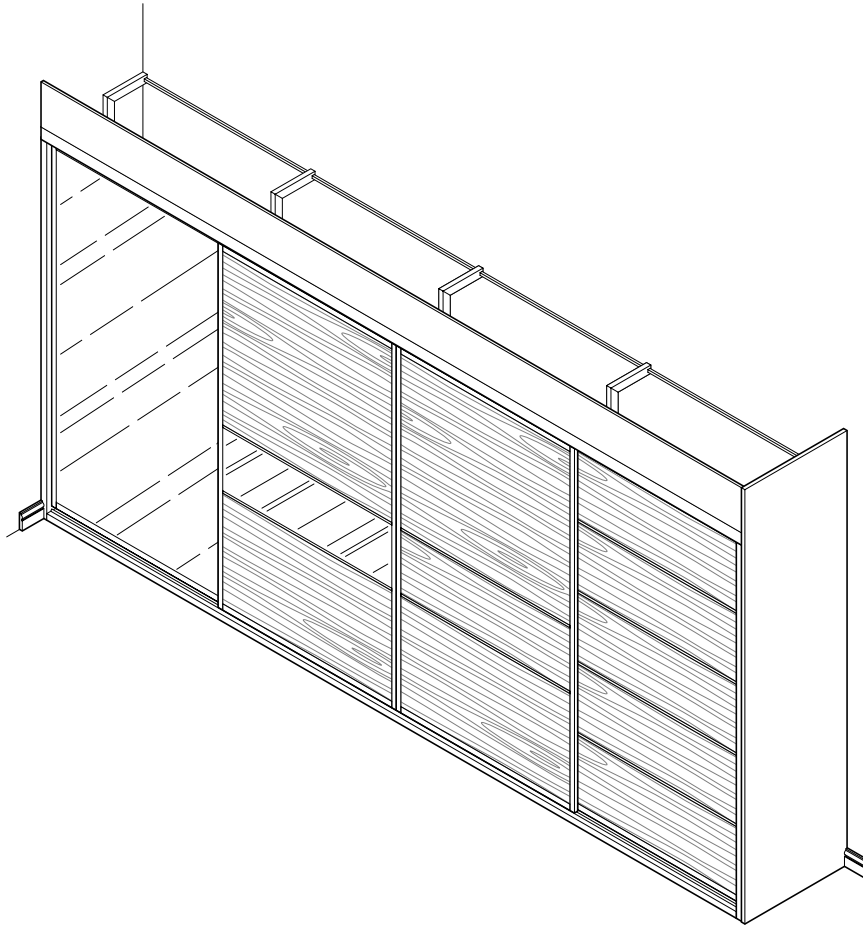

LOW UNITS AND ACCESSORIES ARE AVAILABLE

**CLOSET DOOR DETAILS
(ANGLING RESTRICTIONS APPLY)**

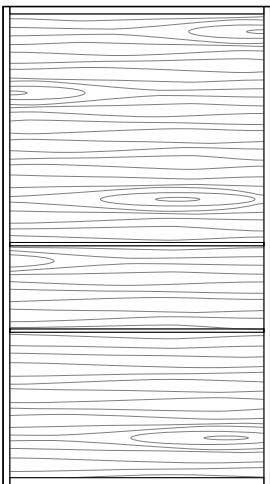

3 PANELLED DOOR
STANDARD SOLID

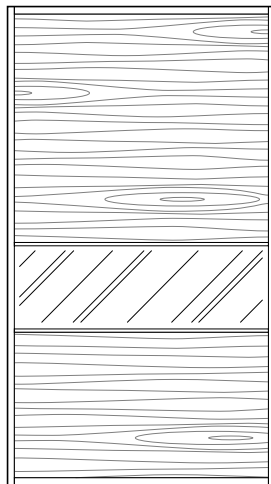

3 PANELLED DOOR
GLAZED OR MIRRORED

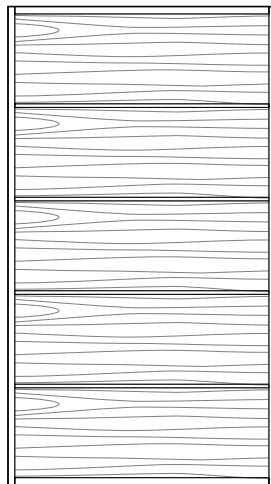



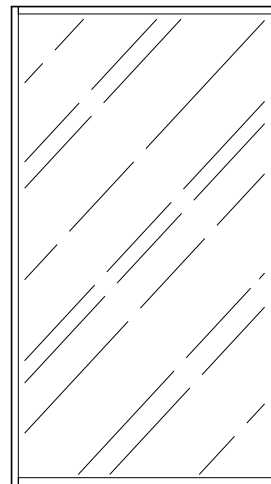

5 PANELLED DOOR
SOLID, GLAZED OR MIRRORED
2090 height ONLY

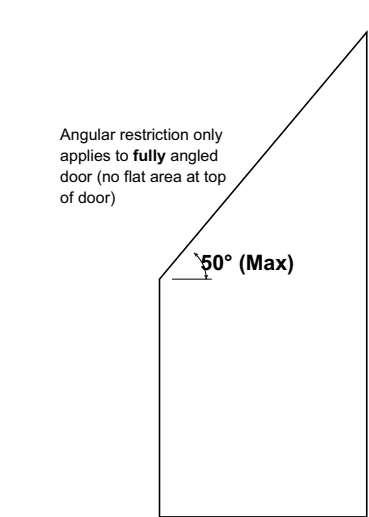
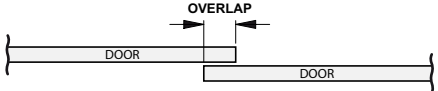
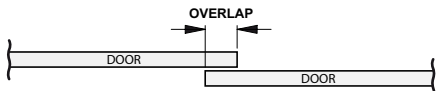
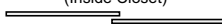
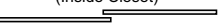
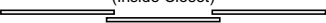

SINGLE PANELLED DOOR
SOLID, GLAZED OR MIRRORED
(Mirrored not available in 2300 height)

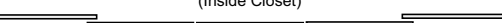
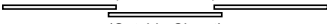
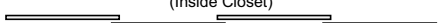
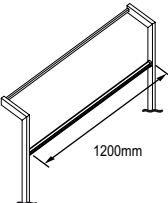
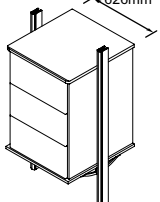
WILLOUGHBY CLOSETS

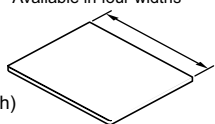
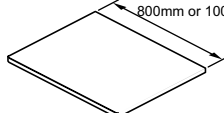
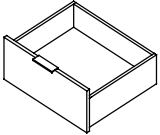
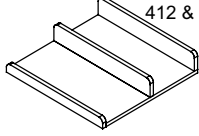
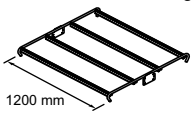
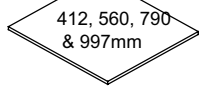
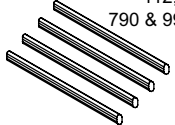
STANDARD DETAILS				ANGLED DOOR DETAILS		DESIGN CONSIDERATIONS	
Doors	UNIT HEIGHTS	DOOR WIDTHS	CAN BE ANGLED	ANGLED DOOR RESTRICTIONS			
Doors						<p>Closet runs should not be designed with a side panel at both ends.</p> <p>Internal Chests should not be planned in configurations containing 610mm Doors.</p> <p>All Doors are Soft Close Angled Doors CANNOT have Soft Close.</p> <p>It is recommended that only two Angled Doors are fitted next to each other wherever possible.</p> <p>A shelf (including mounting track) must be fitted behind Angled Doors to ensure correct operation.</p> <p>These doors cannot be mixed with other contemporary closet doors.</p> <p>Please note that doors are handed.</p>	
Standard Panel	1977, 2090, 2205, 2300	610, 675, 754, 915, 1220	YES				
Mirrored	1977, 2090, 2205	610, 675, 754, 915	NO				
DOOR DETAILS (NOT ANGLED)				DOOR DETAILS (ANGLED DOORS)			
Door Overlaps (Plan view)				Door Overlaps (Plan view)			
							
Door width	Min Overlap	Max Overlap					
610	40mm	70mm					
675	40mm	70mm					
754	40mm	70mm					
915	40mm	100mm					
1220	40mm	130mm					
Door Configurations (Plan views)				Door Configurations (Plan views)			
<p>2 Doors (LH) (Inside Closet)</p>  <p>(Outside Closet)</p> <p>2 Doors (RH) (Inside Closet)</p>  <p>(Outside Closet)</p> <p>3 Doors (Inside Closet)</p>  <p>(Outside Closet)</p> <p>4 Doors (Inside Closet)</p>  <p>(Outside Closet)</p> <p>5 Doors (Inside Closet)</p>  <p>(Outside Closet)</p>				<p>Note: Where angled doors are to be included in a run of doors, AT LEAST 2 of all of the doors MUST NOT BE angled. Furthermore, the non angled doors must be fitted next to each other to ensure the correct operation of all doors!</p> <p>3 Doors (Minimum 2 Doors must not be angled) (Inside Closet)</p>  <p>(Outside Closet)</p> <p>4 Doors (Minimum 2 Doors must not be angled) (Inside Closet)</p>  <p>(Outside Closet)</p>			
Doors CANNOT be altered in height or width				Doors CANNOT be altered in height or width (Fully angled doors will naturally alter in height)			
CONTEMPORARY INTERIORS				WOODEN INTERIORS			
<p>HANGING RAIL (Can be cut down in length) (Shown between Stanchions)</p>  <p>1200mm</p>		<p>INTERNAL CHESTS 468mm, 626mm</p> 		<p>HANGING RAILS 4 widths 412, 560, 790 & 997mm</p> 		<p>Available in PEARWOOD & URBAN WALNUT finishes.</p>	
<p>SQUARE EDGED SHELVES Available in four widths</p>  <p>468mm, 626mm, 800mm or 1000mm</p>		<p>ANGLED SHELVES (For use behind ANGLED doors) (Can be reduced in width & depth) 468mm, 626mm, 800mm or 1000mm</p> 		<p>INTERNAL DRAWERS 2 widths 412 & 560mm</p>  <p>Solid internal 18mm sides</p>		<p>PULL OUT SHOE TRAYS 2 widths 412 & 560mm</p> 	
<p>SHOE RAIL (Can be cut down in length)</p>  <p>1200mm</p>				<p>SHELVES 4 widths 412, 560, 790 & 997mm</p> 		<p>SHOE RAILS 4 widths 412, 560, 790 & 997mm</p> 	

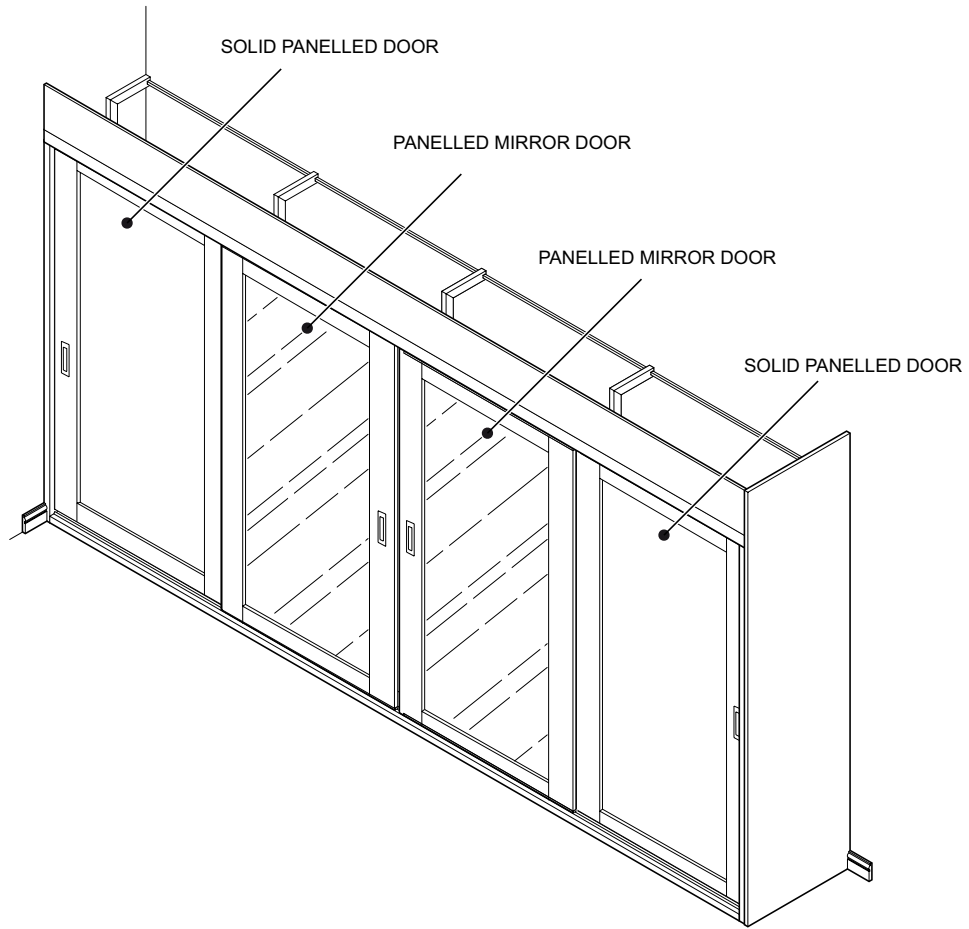

LOW UNITS AND ACCESSORIES ARE AVAILABLE IN THE WILLOUGHBY RANGE

CLOSET DOOR DETAILS
(ANGLING RESTRICTIONS APPLY)

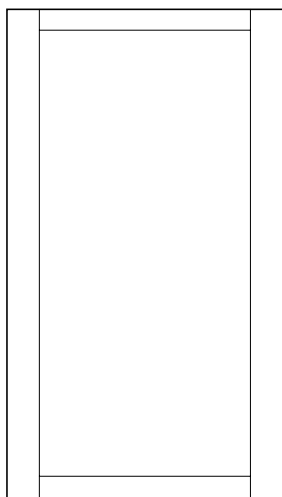



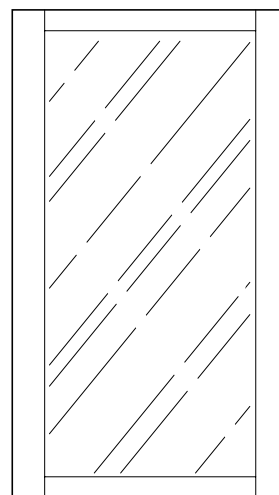

PANNELLED DOOR

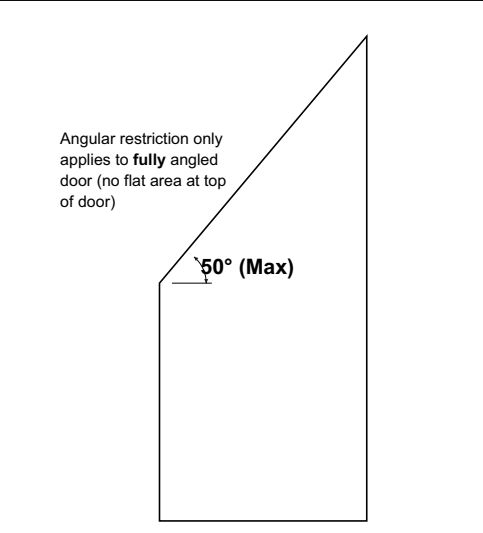
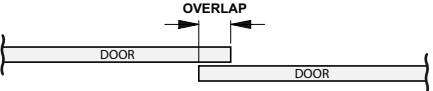
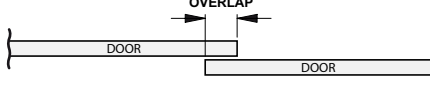
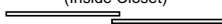
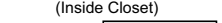
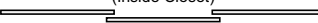

PANNELLED MIRROR DOOR

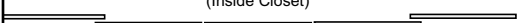
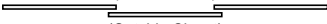
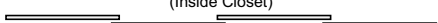
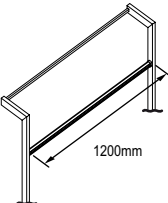
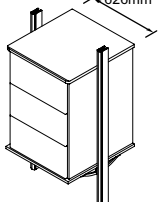
VIGO SLIDING WARDROBES

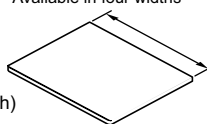
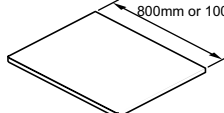
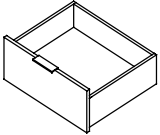
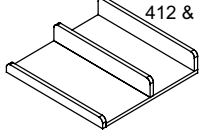
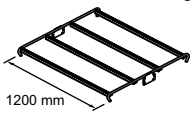
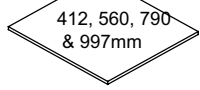
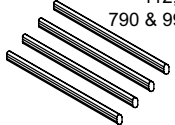
STANDARD DETAILS				ANGLED DOOR DETAILS		DESIGN CONSIDERATIONS	
Doors	UNIT HEIGHTS	DOOR WIDTHS	CAN BE ANGLED	ANGLED DOOR RESTRICTIONS			
Doors						<p>Closet runs should not be designed with a side panel at both ends.</p> <p>Internal Chests should not be planned in configurations containing 610mm Doors.</p> <p>All Doors are Soft Close Angled Doors CANNOT have Soft Close.</p> <p>It is recommended that only two Angled Doors are fitted next to each other wherever possible.</p> <p>A shelf (including mounting track) must be fitted behind Angled Doors to ensure correct operation.</p> <p>These doors cannot be mixed with other contemporary closet doors.</p> <p>Please note that doors can be supplied with or without a handle. With a handle they are handed.</p>	
Standard Panel	1977, 2090, 2205, 2300	610, 675, 754, 915, 1220	YES				
Mirrored	1977, 2090, 2205	610, 675, 754, 915	NO				
DOOR DETAILS (NOT ANGLED)				DOOR DETAILS (ANGLED DOORS)			
Door Overlaps (Plan view)				Door Overlaps (Plan view)			
							
Door width	Min Overlap	Max Overlap					
610	40mm	70mm					
675	40mm	70mm					
754	40mm	70mm					
915	40mm	100mm					
1220	40mm	130mm					
Door Configurations (Plan views)				Door Configurations (Plan views)			
<p>2 Doors (LH) (Inside Closet)</p>  <p>(Outside Closet)</p> <p>2 Doors (RH) (Inside Closet)</p>  <p>(Outside Closet)</p> <p>3 Doors (Inside Closet)</p>  <p>(Outside Closet)</p> <p>4 Doors (Inside Closet)</p>  <p>(Outside Closet)</p> <p>5 Doors (Inside Closet)</p>  <p>(Outside Closet)</p>				<p>3 Doors (Minimum 2 Doors must not be angled) (Inside Closet)</p>  <p>(Outside Closet)</p> <p>4 Doors (Minimum 2 Doors must not be angled) (Inside Closet)</p>  <p>(Outside Closet)</p>			
Doors CANNOT be altered in height or width				Doors CANNOT be altered in height or width (Fully angled doors will naturally alter in height)			
METAL STANCHION INTERIORS				WOODEN INTERIORS			
<p>HANGING RAIL (Can be cut down in length) (Shown between Stanchions)</p>  <p>1200mm</p>		<p>INTERNAL CHESTS 468mm, 626mm</p> 		<p>HANGING RAILS 4 widths 412, 560, 790 & 997mm</p> 		<p>Available in PEARWOOD & URBAN WALNUT finishes.</p>	
<p>SQUARE EDGED SHELVES Available in four widths</p>  <p>468mm, 626mm, 800mm or 1000mm</p>		<p>ANGLED SHELVES (For use behind ANGLED doors) (Can be reduced in width & depth) 468mm, 626mm, 800mm or 1000mm</p> 		<p>INTERNAL DRAWERS 2 widths 412 & 560mm</p>  <p>Solid internal 18mm sides</p>		<p>PULL OUT SHOE TRAYS 2 widths 412 & 560mm</p> 	
<p>SHOE RAIL (Can be cut down in length)</p>  <p>1200mm</p>				<p>SHELVES 4 widths 412, 560, 790 & 997mm</p> 		<p>SHOE RAILS 4 widths 412, 560, 790 & 997mm</p> 	

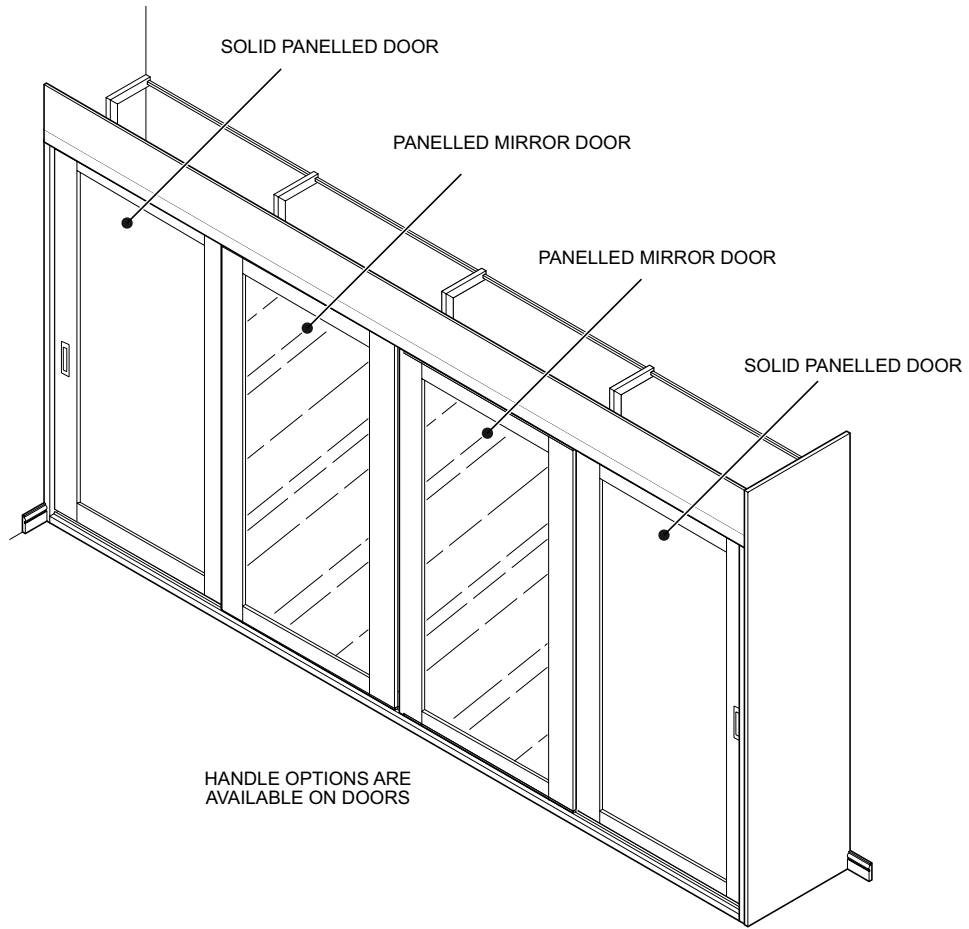

LOW UNITS AND ACCESSORIES ARE AVAILABLE IN THE VIGO RANGE

SLIDING WARDROBE DOOR DETAILS
(ANGLING RESTRICTIONS APPLY)

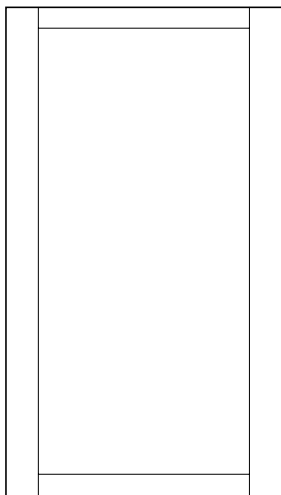

PANELLED DOOR

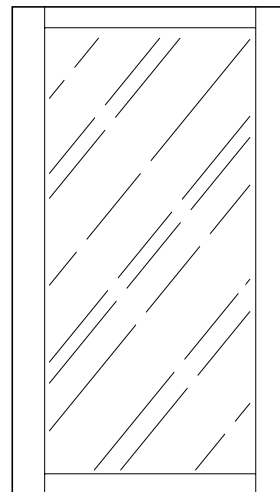

PANELLED MIRROR DOOR
OR PANELLED WITH COLOUR INSET